



bizhub C4050i/C3350i

Specification & Installation Guide



KONICA MINOLTA

bizhub C4050i/C3350i Specifications	
Type	Full Color Printer/Copier/Scanner
Document Holder	Stationary (mirror scanning)
Photoconductor	OPC
Luminous Source	LED light-source illumination
Copying System	Laser electrostatic copy method
Developing System	Dry-2 component developing method
Resolution	Scanning: 600 x 600 dpi Printing: 1200 x 1200 dpi
Document Holder	Types: Sheets, books (2-page spreads), three-dimensional objects Size: Maximum 8.5" x 14"
Paper	Thin Paper (14 lb to 15.5 lb)* Plain Paper (16 lb to 24 lb) Plain Paper+ (24.75 lb to 28 lb) Thick Paper 1 (24.25 lb to 32 lb) Thick Paper 1+ (32.25 lb to 41.75 lb) Thick Paper 2 (42 lb to 55.5 lb) Thick Paper 3 (55.75 lb to 68 lb) Thick Paper 4 (68.25 lb to 79.75 lb)** Recycled Paper (16 lb to 24 lb) Special Paper (16 lb to 24 lb) Letterhead (16 lb to 24 lb) Color Paper (16 lb to 24 lb) 1-Sided Special Paper (16 lb to 24 lb) Banner Paper** (34 lb to 55.5 lb) OHP Transparencies**, envelopes**, label sheets**, tabs**, postcards** *Cannot be fed through the bypass tray. **Can only be fed through the bypass tray; Monochrome copying/printing on transparencies is supported. Color copying/printing on transparencies is NOT supported.
Copy Sizes	1st Tray: 3.9" x 5.8" to 8.5" x 11" Bypass Tray: 3.5" x 8.8" to 8.5" x 14"
Paper Tray Capacity	1st Tray: Thin Paper/Plain Paper/Recycled Paper/Special Paper/Color Paper/ 1-Sided Special Paper: 500 sheets Thick Paper 1/1+/2: 20 sheets Envelopes: 30 Postcards/Label Sheets: 20 sheets Bypass Tray: Plain Paper/Recycled Paper/Special Paper/Letterhead/Color Paper/ 1-Sided Special Paper: 100 sheets Thick Paper 1/1+/2/OHP Transparencies/Postcards/Tabs: 20 sheets Envelopes: 10 Banner Paper/Label Sheets: 10 sheets

continued

bizhub C4050i/C3350i Specifications	
Warm-Up Time	Color and BW less than 15 seconds (at room temperature/73° F)
Image Loss Width	Leading edge: 0.116" ± 0.079" Trailing edge: 0.116" ± 0.079" Rear edge: 0.116" ± 0.079" Front edge: 0.116" ± 0.079"
First Copy	C4050i: Color: 5.4 sec. or less B/W: 4.8 sec. or less C3350i: Color: 6.3 sec. or less B/W: 5.6 sec or less
Print Speed* (Full Color/B&W) (Simplex/Duplex)	bizhub C4050i: Plain paper: 42 sheets/min. Thick 1/Thick1+/Thick 2: 21 sheets/min.
	bizhub C3350i: Plain paper: 35 sheets/min. Thick 1/Thick 1+/Thick 2: 17 sheets/min.
Magnification Ratios (Preset)	1.0 (full size: 1.00 ± 0.5% or less) Enlarge: 129.4%, 154.5%, 200% Reduce: 78.5%, 64.7%, 60.7%, 50.0% Stored Zoom Ratios: 3
Multiple Copies	1 to 9,999 sheets
Density Control	Copy Density: Manual Density Adjustment (9 Levels) Background Density: Automatic and Manual Density Adjustments (9 levels)
Power Requirements	120V, 12 A, 60 Hz
Power Consumption	1.45 kW or less
TEC Value	C4050i: 6.35 kWh C3350i: 4.95 kWh
Dimensions (with control panel)	18.5" (W) x 20.8" (D) x 22.5" (H)
Space requirements*	30.8" (W) x 37.6" (D) x 31.2" (H)
Memory	5 GB (Std.)
Solid State Drive	250 GB (Std.)
Weight	Approx. 86 lb

* The indicated space requirements represent the space required to pull out the paper tray and the tray extension of the bypass tray and with the ADF open.

Duty Cycle

C4050i: Up to 120,000.

C3350i: Up to 96,000.

Maximum monthly copy/print volume supported under standard vendor supplied service. Defines the upper end of the expected customer volume for the device. Customers should consider multiple machines if average monthly volume approaches duty cycle on continual basis.

Environmental Requirements	
Temperature	50° F to 86° F
Humidity	15% to 85%
Noise During Operation	C4050i: 72.5 dB C3350i: 71.5 dB
Noise During Standby	43.5 dB or less
Ozone Emission	Color: 0.5 mg/h B/W: 0.25 mg/h

Electrical Requirements		
Line Options	Dedicated	NEMA Diagram for 5-15R 
Voltage	110 V/120 V	
Amperage	12 A	
Cycles	60 Hz	
NEMA Part No.	5-15R	
Cord Length	6.6 ft.	
Note: The main electrical outlet must be located within 6.6 feet from the right rear corner of the bizhub C4050i/C3350i main unit.		

Basic Configuration





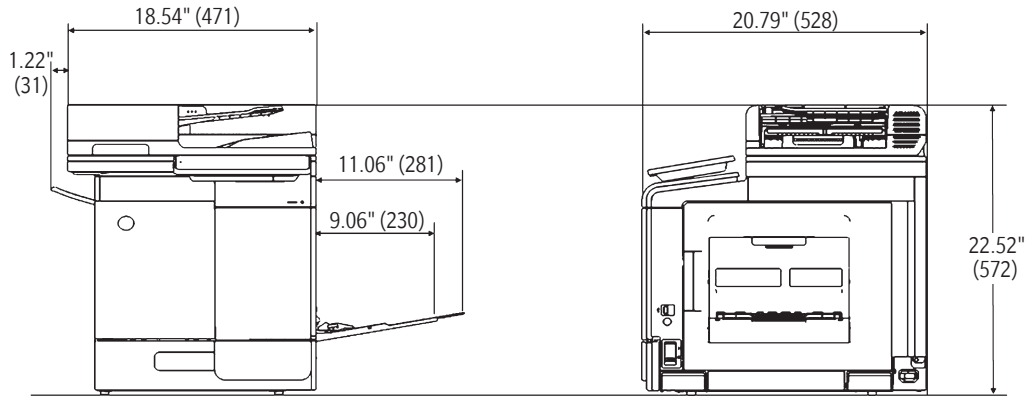

Space Requirements

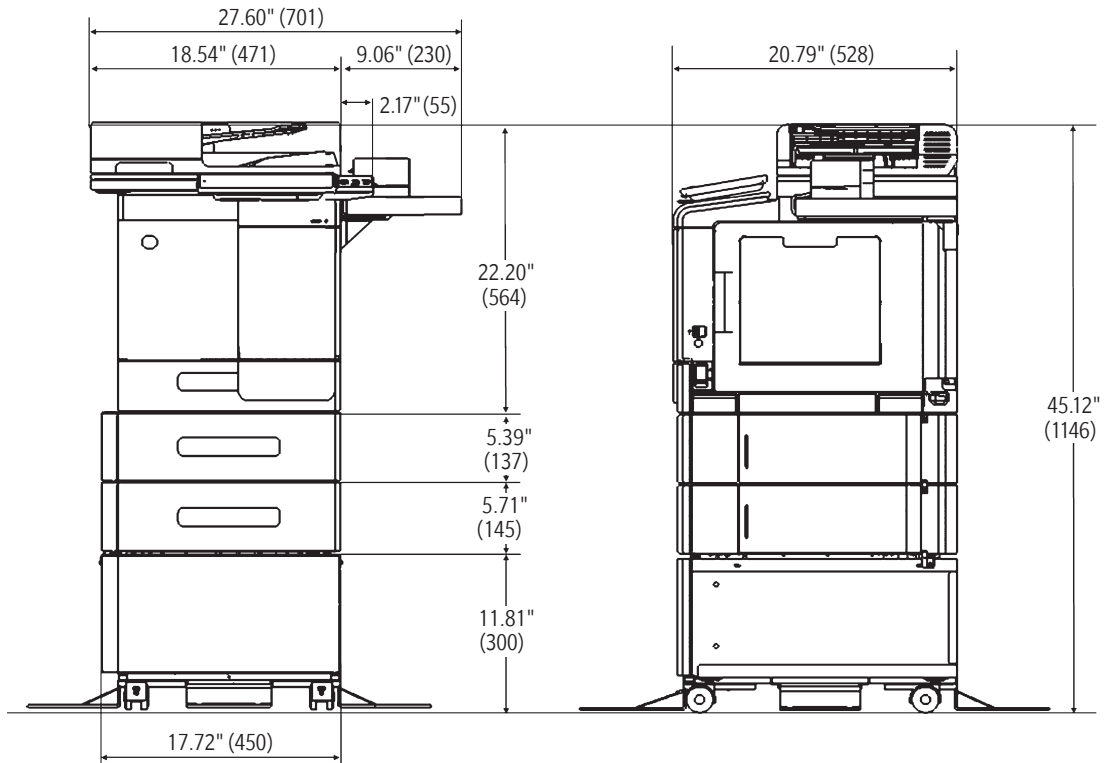

bizhub C4050i/C3350i





bizhub C4050i/C3350i + PF-P21 + PF-P21 + DK-P05

Accessories	
Automatic Duplex Unit (Standard)	
	
Support Paper Type	Plain Paper (16 lb to 24 lb) Thick Paper 1 (24.25 lb to 32 lb) Thick Paper 1+ (32.25 lb to 41.75 lb) Thick Paper 2 (42 lb to 55.5 lb) Recycled Paper (16 lb to 24 lb) Special Paper (16 lb to 24 lb) Color Paper (16 lb to 24 lb)
Support Paper Size	4.7" x 8.8" to 8.5" x 14"
Power Requirements	Supplied from main unit
Dual Scanner Document Feeder (Standard)	
	
Type	Single Pass Duplex Document Feeder
Support Paper Size	1-Sided/2-Sided Originals/Mixed Originals: 8.5" x 14"  to 5.5" x 8.5" 
Support Paper Weight	Single-Sided/Double-Sided: 13.5 lb bond to 34 lb bond Mixed Original: 13.5 lb bond to 34 lb bond 1-Sided Plain Paper (13.25 lb to 34 lb) 2-Sided Plain Paper (13.25 lb to 34 lb) Mixed Original Plain Paper (13.25 lb to 34 lb)
Paper Capacity	Max. 80 sheets (21.25 lb) (Single-Sided/Double-Sided Originals)
Scan Speed	100 images/min (one-sided @ 200 dpi) (B&W/Color) 200 images/min (double-sided @ 200 dpi) (B&W/Color)
Power Requirements	Supplied from main unit.

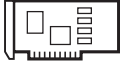

continued

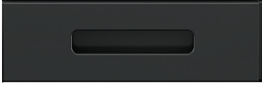
Accessories	
FK-517 Fax Kit (Standard on C4050i/Optional on C3350i)	
	
Number of Stored Pages	10,000 Pages (approx. 700 characters per page when 8.5" x 11" document is stored using fine resolution)
Number of Fax Lines	1 Fax Line (Standard); Add second FK-517 Fax Kit for dual line fax capabilities.
Communication	ECM/Super G3
Compatible Lines	PSTN, PBX
Scanning Line Density	Ultra Fine: 600 x 600 dpi Super Fine: 16 dot/mm x 15.4 line/mm, 400 x 400 dpi Fine: 8 dot/mm x 7.7 line/mm, 200 x 200 dpi Normal: 8 dot/mm x 3.85 line/mm
Modem Speed	2.4 kbps-33.6 kbps
Compression	MH/MR/MMR/JBIG
Scanning/ (Sending) Paper Size	Original Glass: Max. 11" x 17" ADF: 11" x 39" (Normal, Fine, Super Fine) 11" x 17" (Ultra Fine, Manual TX)
Recording Paper Size	8.5" x 14" to 5.5" x 8.5"
Transmission Speed	Less than 2 sec. (A4, V.34, 33.6 Kbps, JBIG)
Scan Speed	2 sec. (Letter/Fine Mode)
Number of Abbr. Dial	2000
Number of Program Dial	400
Number of Group Dial	100 (Up to 500 destinations per group)
Sequential Multiple	Max. 600 Station Transmission
Transmitting Functions	2-in-1 TX, Mixed Original, F-Code Transmission, Frame Erase Transmission, Sharpness, Header/Footer, Memory Transmission, Quick Memory Transmission, Timer Transmission, Incomplete Transmission Hold, Manual Transmission, Confidential Transmission, Password Transmission, Polling Transmission, Bulletin Function, Relay Transmission, Fax Forwarding Function, Overseas TX, V.34 OFF, ECM OFF
Receiving Functions	Duplex Print (RX), Manual Reception, Confidential Reception, Memory Reception, Polling Reception, Bulletin Function, Fax Forwarding (to any destination stored in the Address Book), TSI Routing (to any destination stored in the Address Book).

continued

Accessories	
PF-P21 Paper Feed Cabinet (Add up to two)	
	
Type	1 x 500 sheet drawer
Support Paper Types	Plain Paper (16 lb bond to 24 lb bond), Recycled Paper (16 lb to 24 lb), Single Side Only Paper (16 lb bond to 24 lb bond), Special Paper (16 lb bond to 24 lb bond), Letterhead (16 lb bond to 24 lb bond), Colored Paper (16 lb bond to 24 lb bond)
Supported Paper Size	8.5" x 14" to 7.25" x 10.5"
Paper Capacity	500 sheets (21 lb)
Power Requirements	Supplied from Main Unit
Max. Power Consumption	Less than 15W
Dimensions (W x D x H)	17.7" x 20.8" x 5.7"
Weight Approx.	18.5 lb
PF-P25 Height Adjustment Unit	
	
Type	Height Adjustment Unit
Function	Increases working height of the machine. Suggested if the machine is configured with the DK-P05 and fewer than two PF-P21 Paper Feeder Cabinets.
DK-P05 Copy Desk	
	
Type	Storage drawer only
Function	Stores printing materials such as paper or toner. Recommended when additional paper drawers are installed, to bring the device to operational height
Dimensions (WxDxH)	17.7" x 20.8" x 13.8"
Weight Approx.	30 lb

continued

Accessories	
KP-102 10-Key Pad	
	
Type	10-Key Pad
Function	Provides hard keys for entering numerical values and supports Voice Guidance function available with optional LK-104 v3 i-Option License Kit. Meets Section 508 Accessibility requirements.
External Keyboard	
	
Type	QWERTY Keyboard
Function	Computer-type keyboard for alphanumeric data entry. Requires KH-P02 Keyboard Holder and EK-P08 or EK-P09 USB Interface Kit.
KH-P02 Keyboard Holder	
Type	Mount Kit
Function	Required for installation of External Keyboard
AU-102 Biometric Authentication Unit	
	
Biometric Sensor System	Transmission-type optical system
Verification Time	Approx. 1 sec. or less
Interface	USB 2.0
Dimensions WxDxH	Approx. 2.32" x 3.25" x 2.94"
Weight	Approx. 3 oz. (excluding USB cable)
Max. Power Consumption	DC 5 V, 500 mA
System Conditions	Ambient temperature: 41° to 95° (F) (during operation) Humidity: 20% to 80% (No dew condensation)
System Conditions (during non-operation)	Ambient temperature: 32° to 122° (F) Humidity: 20% to 80% (No dew condensation)
MFP Compatibility	bizhub C754e, C654e, C554e, C454e, C360i, C300i, C284, C224e, C224. Please check MyKonicaMinolta.com on a regular basis for compatibility updates.
	NOTE: WT-P03 Working Table is required for AU-102 Biometric Authentication Unit.

continued

Accessories



AU-204H Magnetic Stripe Card Reader

	
Dimensions (WxHxD)	1.28" x 1.23" x 3.94"
Weight	4.5 oz.
Power Supply	Supplied from USB Port
System Conditions (operating mode)	Ambient Temperature: 40° to 158° F Humidity: 10% to 90%
Transmit Frequency	3-60 i.p.s.
Certifications	ISO 7810 and ISO 7811/AAMVA
Card Type Compatibility	All magnetic stripe cards
MFP Compatibility	bizhub C754e, C654e, C554e, C454e, C360i, C300i, C224e. Please check MyKonicaMinolta.com on a regular basis for compatibility updates.
	NOTE: WT-P03 Working Table required for AU-204H Magnetic Stripe Card Reader.

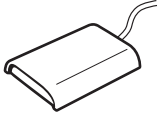
AU-205H IC Card Reader

	
Dimensions (WxHxD)	2.79" x 3.66" x 0.63"
Weight	0.25 lb
Power Supply	Supplied from USB Port
System Conditions	Ambient Temperature: 31° to 150° F (operating mode) Humidity: 5% to 95%
Card/Protocols	HID PROX, HID Indala® Prox, EM Prox Low Frequency (125 kHz)
Card/Protocols High Frequency (13.5 MHz)	CCID: MIFARE Classic™ 1K/4K, Ultra Light, Ultra Light C, Plus, MIFARE DESFire™ 0.6, MIFARE DESFire™ EV1, IC Card, iClass SE/SR®, MIFARE SE™, DESFire EV1 SE, T=CL, ISO 14443 A with up to 848 kbps transmission rate (depending on card*), ISO 15693 with up to 26 kbps transmission rate (depending on card)
	NOTE: WT-P03 Working Table or MK-P08 Mount Kit (internal mount) required. *424 kbps default rate, 848 kbps configurable through web interface.

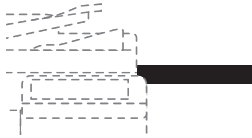
continued

Accessories	
AU-211P CAC/PIV Solution w/Certificate	
	
Dimensions (WxHxD)	2.75" x 2.75" x 0.39"
Weight	0.13 lb
Power Supply	Supplied from USB Port
System Conditions	0° to 122° F (operating mode)
Interface	Full Speed USB (12 Mbps)
Connector Shape	USB A Type Connector
Compatible Card	PKI-C-Card (PIV, CAC)
MFP Compatibility	bizhub C754e, C654e, C554e, C454e, C360i, C300i, C224e. Please check MyKonicaMinolta.com on a regular basis for compatibility updates.
	NOTE: WT-P03 Working Table required. Please contact your local Government Account Manager for additional information.
MK-P08 Mount Kit	
Type	Internal Component
Function	Required for internal installation of AU-205H
WT-P03 Working Table	
	
Type	External Table
Function	Holds AU-102 Biometric Authentication Unit, AU-201H HID Proximity Card Reader, AU-202H HID iClass Reader, AU-204H Magnetic Stripe Card Reader, AU-205H IC Card Reader or AU-211P CAC/PIV Solution; Can be used as a place holder for originals and/or output.
Dimensions WxDxH	9.1" x 13.4" x 1.1"
EK-P08 USB Host/Local Interface	
	
Type	USB Interface
Function	Required to connect optional External Keyboard or optional i-Option LK-104 v3 Voice Guidance License kit.

continued

Accessories	
LK-P09 USB Host/Local Interface with Bluetooth	
Type	USB Interface with Bluetooth
Function	Required to connect optional External Keyboard or optional i-Option LK-104 v3 Voice Guidance License Kit.
LK-102 v3 i-Option License Kit	
Type	License Key
Function	Enhanced PDF Encryption (128-bit AES Encryption), PDF/A (1a/1b) and Linearized PDF file support.
	Note: The LK-110 v2 supports the same functions as the LK-102 v3, therefore, both license kits cannot be installed on the same device.
LK-104 v3 i-Option License Kit	
Type	License Key
Function	Voice Guidance
LK-105 v4 i-Option License Kit	
Type	License key
Function	Provides Searchable PDF function
	Note: The LK-110 v2 supports the same functions as the LK-105 v4, therefore, both license kits cannot be installed on the same device.
LK-106 i-Option License Kit	
Type	License key
Function	Supports Bar Code Font Printing
LK-107 i-Option License Kit	
Type	License key
Function	Supports Unicode Font Printing
LK-108 i-Option License Kit	
Type	License key
Function	Supports OCR Font Printing
LK-110 v2 i-Option License Kit	
Type	License Key
Function	OOXML format file conversion for docx/xlsx, Fax to searchable PDF, convert box data to compact PDF, direct print e-mail attached file. Combines LK-102 (Encrypted PDF) & LK-105 (Searchable PDF/OCR) functionality.
	Note: If you install the LK-110 v2 on a device, you cannot install the LK-102 v3 and/or LK-105 v4 on the same device.
LK-111 i-Option License Kit	
Type	License Key
Function	Provides ThinPrint client support.
LK-116 i-Option License Kit	
Type	License Key
Function	Bitdefender antivirus provides real-time scanning of all input and output data.

continued

Accessories

CS-1 Convenience Stapler



Type	Standalone electronic stapler
Stapling Capacity	Up to 50 sheets
Paper Weight	Up to 90 gsm
Durability Cycle	Up to 200,000 stapling operations
Staple Position	Side or corner of document
Type of Clinch	Flat clinch
Dimensions (WxHxD)	5.3" x 5.7" x 7.5"
Weight	Approx. 4 lb
Power Supply	AC adaptor (supplied). Separate power output required.
Refill Staples	SK-602 (No. 505: 5,000 staples)

FS-P04 Off-Line Stapler



Type	Stapling (off-line)
Staple capacity	20 sheets (90 gsm)
Power supply	From device
Staples	SK-501
Dimensions (WxHxD)	4.3" x 4.6" x 2.9"
Weight	Approx. 2 lb
Function	Provides finishing capabilities. Can be installed on working table WT-P03 or separately.

Mixed Original Support		
	Maximum Document Width ¹	
Document Size ²	8.5" x 14" landscape	8.5" x 11" landscape
8.5" x 14" (📄)	●	●
8.5" x 11" (📄)	●	●

¹ Indicates the width of the widest document size of the mixed originals.

² Indicates the document sizes that can be mixed together based on the maximum document width.

Standard Paper Tray Support			
Main Unit - bizhub C4050i/C3350i (Paper Tray 1)			
Component	Capacity	Size	Weight
Tray 1	500 sheets	8.5" x 11"	14 lb bond to 24 lb bond
Bypass	150 sheets	8.5" x 14"	16 lb bond to 79.75 lb bond

Print Controller (Standard)										
Type	Internal Type									
CPU	1.6 GHz Quad Core Processor (shared with copier)									
Memory	5 GB (shared with copier) 250 GB Solid State Drive (shared with copier)									
Print Speed	<table border="0"> <tr> <td></td> <td>C4050i:</td> <td>C3350i:</td> </tr> <tr> <td>Color/BW:</td> <td>42 ppm</td> <td>35 ppm</td> </tr> <tr> <td>Letter</td> <td>☐</td> <td>☐</td> </tr> </table>		C4050i:	C3350i:	Color/BW:	42 ppm	35 ppm	Letter	☐	☐
	C4050i:	C3350i:								
Color/BW:	42 ppm	35 ppm								
Letter	☐	☐								
Print Resolution	600 x 600 dpi (1800 equivalent x 600 dpi), 1200 x 1200 dpi									
PDL	PCL 5e/c emulation, PCL6 (XL version 3.0), PS 3 (Version 3016) Emulation, XPS									
Protocol	TCP/IP (IPv4/IPv6), BOOTP, ARP, ICMP, DHCP, DHCPv6, AutoIP, SLP, SNMP, FTP, LPR/ LPD, RAW Socket, SMB over TCIP/IP, IPP, HTTP, POP, SMTP, LDAP, NTP, SSL, IPX, AppleTalk, Bonjour, NetBEUI, WebDAV, DPWS, S/MIME, IPsec, DNS, Dynamic DNS, LLMNR, LLTD, SSDP, SOAP									
Font	PCL Resident Fonts: 80 Roman fonts PS3 Emulation Resident Fonts: 137 Roman Type 1 fonts									
Interface	Standard Ethernet (10Base-T/100Base-TX/ 1000Base T); Hi-Speed USB 2.0, USB 1.1, USB Host									

Network Functions	
Sending the Scanned Data in an Email Message	Sending Scanned Data in an Email Message Scanned data can be sent to a specified Email address. The destination is specified from the touch panel of this machine and the scanned data is sent as an Email attachment.
Sending Scanned Data as Files (FTP)	Scanned data is uploaded to a specified FTP server. The FTP server address, login password, and other information are entered from the touch panel of this machine. The data files uploaded to the FTP server can be downloaded from a computer on the network.
Sending Scanned Data to a Computer on the Network (SMB)	Scanned data can be sent to a shared folder on a specified computer. The name of the destination computer, login password, and other information are entered from the touch panel of this machine.
Saving Scanned Data in Boxes	Scanned data is uploaded to a specified web server. The host name, file path, user name, and password are entered on the touch panel of the machine. The data files uploaded to the server can be downloaded from a computer on the network.
Using the Machine as a Scanner	This machine can best used as a scanner. The scanner can be controlled from a PC connected to the network, and the scanned image can be loaded into an application on the PC to be processed.
Web Service (Standard)	This machine can be used to access the Internet.

Print Drivers		
PCL 6 Drivers	Konica Minolta PCL Driver	Windows 7/8.1/10 Windows 7/8.1/10 64-bit Windows Server 2008 Windows Server 2008/2008 R2/Server 2012/Server 2012 R2/ Server 2016 64-bit
PostScript 3 Emulation	Konica Minolta PostScript3 Driver	Windows 7/8.1/10 Windows 7/8.1/10 64-bit Windows Server 2008 Windows Server 2008/2008 R2/Server 2012/Server 2012 R2/ Server 2016 64-bit Macintosh OSX 10.9/10.10/10.11/10.12/10.13 PPD+PDE printer driver PPD file for Red Hat Enterprise Linux (CUPS ver. 1.1.22)
XPS Driver Emulation	Konica Minolta XPS Driver	Windows 7/8.1/10 Windows 7/8.1/10 64-bit Windows Server 2008 Windows Server 2008/2008 R2/Server 2012/Server 2012 R2/ Server 2016 64-bit
Fax Driver	Konica Minolta	Windows 7/8.1/10 Windows 7/8.1/10 64-bit Windows Server 2008 Windows Server 2008/2008 R2/Server 2012/Server 2012 R2/ Server 2016 64-bit

Scanning Function	
Type	Full-Color Scanner
Scanning Size	8.5" x 14" to 5.5" x 8.5"
Scanning Resolution	Push Scanning: 600/400/300/200 dpi Pull Scanning: 600/400/300/200/100 dpi
Scanning Speed	Duplex: 96 opm (300 dpi) Simplex: 48 opm (300 dpi)
Main Function	Scan-to-Email, Scan-to-User Box (HDD), Scan-to-FTP, Scan-to-USB, Scan-to-SMB (Desktop Folder), Scan-to-Me, Scan-to-Home, Scan-to-Scan Server, Network Twain (via Ethernet TCP/IP), Scan-to-WebDAV, WS-Scan
Interface	10Base-T/100Base-TX/1000Base-T
Protocol	TCP/IP (FTP, SMB, SMTP)
Supported OS	Windows 7/8.1/10, Windows 7/8.1/10 64-bit
Output Format	Single TIFF, Multi TIFF, JPEG, PDF, Compact PDF, XPS, Compact XPS TIFF (MH, MMR), PDF (MH, MMR, JPEG), JPEG, Outline PDF, PPTX, Searchable PDF, PDF/A, Linearized PDF
Driver	Real Time TWAIN Driver, HDD TWAIN Driver
Address Setting	LDAP, Import/Export address from PageScope Web Connection
Authentication	SMTP Authentication, Network User Authentication (Active Directory, Novell, NDS, NTLM ver. 1, NTLM ver. 2, LDAP)

† Text and image scanning speeds vary depending on the type of document.

Software Tools	
Network & Device Management	Data Administrator Driver Packaging Utility Log Management Utility Net Care Device Manager (Standard)
User Tools	Direct Print Box Operator Print Status Notifier Copy Protection Utility Print Utility for Unix Web Connection
Management Tools	bizhub vCare

Security	
<p>Because information assets are critical, a company needs to effectively protect against the many security risks it faces.</p>	<ol style="list-style-type: none"> 1) Prevent Leaks of proprietary, confidential or personal information 2) Prevent unauthorized use of equipment 3) Effective data encryption 4) Protect data from being altered, duplicated or deleted 5) Prevent unauthorized access to data via the Internet 6) Protect against cyber attacks 7) Manage log history
<p>Protective Functions</p>	<ul style="list-style-type: none"> • Job Erase — Deletes Graphic Data (after each job) • Lock Job (when printing confidential documents) • Protect data by requiring department name and 8-digit password • Account Track • HDD Lock • Prevent Unauthorized Use • Operation Log with 2,000-event memory • SDD Encryption • PDF Scan Encryption • Protective Functions • Copy Protection • Network Authentication • Single Sign-on Authentication • SMTP Authentication for Email • SSL/TSL Compatibility for PS Web Connection, PS Data Administrator and LDAP Server • Scan Data Encryption (TCP/socket SSL Compatibility) • LDAP Authentication • Box Operator Data Encryption • Verification of Box Data Receipt • IP Address Filtering • IP v6 • Encrypted Network Password Printing • Scan-to-USB Memory with User Authentication • Print-from-USB Memory with User Authentication • S/MIME/Encryption • FIPS 140-2 Compliance • IEEE 2600.1 Security Ready • ISO 1540 EAL
<p>Optional Protective Functions</p>	<ul style="list-style-type: none"> • SC-509 Copy Guard Kit • LK-102 v3 Enhanced PDF Scan Encryption • LK-116 Bitdefender Antivirus • AU-102 Biometric Authentication Unit • AU-204H Magnetic Stripe Card Reader • AU-205H IC Card Reader • AU-211P CAC/PIV Solution with Certificate

Paper Considerations

Paper Size Conversion Chart

Paper	Letter	Letter R	Legal	Tabloid	Statement	Statement R
Measurement	8.5" x 11"	11" x 8.5"	8.5" x 14"	11" x 17"	5.5" x 8.5"	8.5" x 5.5"

Paper Weight Conversion Chart

gsm	Bond	Offset	Cover	Tag	Index	Point	Bristol	Caliper	
								inches	mm
60.20	16	40	22	37	33	3.2	27.4	0.0032	0.081
67.72	18	45	24	41	37	3.6	30.9	0.0036	0.092
75.20	20	50	28	46	42	3.8	34.3	0.0038	0.097
90.30	24	60	33	56	50	4.8	41.2	0.0048	0.120
105.35	28	70	39	64	58	5.8	48.1	0.0058	0.147
109.11	29	73	40	62	60	6.0	49.8	0.0060	0.152
116.63	31	81	45	73	66	6.1	53.2	0.0061	0.155
131.68	35	90	48	80	74	6.2	60.1	0.0062	0.157
135.45	36	90	50	82	75	6.8	61.8	0.0068	0.173
146.73	39	100	54	90	81	7.2	67.0	0.0072	0.183
150.50	40	100	56	93	83	7.3	68.7	0.0073	0.185
161.78	43	110	60	100	90	7.4	73.8	0.0074	0.188
165.55	44	110	61	102	92	7.6	75.5	0.0076	0.193
176.83	47	120	65	108	97	8.0	80.7	0.0078	0.198
199.41	53	135	74	122	110	9.0	91.0	0.0085	0.216
203.17	54	137	75	125	113	9.0	92.7	0.0090	0.229
218.22	58	146	80	134	120	9.5	99.6	0.0092	0.234
244.56	65	165	90	150	135	10.0	111.6	0.0095	0.241
252.08	67	170	93	156	140	10.5	115.1	0.0100	0.250
270.90	72	183	100	166	150	11.0	123.7	0.0110	0.289
285.95	76	192	105	175	158	13.0	130.5	0.0130	0.330
308.52	82	208	114	189	170	14.0	140.8	0.0140	0.356
312.00	87	220	120	200	180	15.0	142.4	0.0150	0.380
385.06	105	267	146	244	220	18.0	175.8	0.0175	0.445

Paper Type Specifications	
Thin Paper	Thin Paper is paper weighing between 14 lb to 15.5 lb bond. It can be fed via any paper tray, except the bypass tray.
Normal (Plain Paper)	The Normal paper is used for copying in general and is called "PPC paper." The normal paper is usually not a recycled paper. Specify [Normal] to the tray to which the normal paper or the recycled paper is loaded for copying.
Recycled Paper	Recycled Paper is identified as recycled paper along with a designation as to the percentage of the paper that is actually made from recycled materials. Generally speaking, these devices will support recycled paper weighing between 16 lb to 24 lb bond.
Thick Paper 1	Thick Paper 1 is paper weighing between 24.25 to 32 lb bond It can be fed via any paper tray.
Thick Paper 1+	Thick Paper 1+ is paper weighing between 32.25 to 41.75 lb bond. It can be fed via any paper tray.
Thick Paper 2	Thick Paper 2 is paper weighing between 42 to 55.5 lb bond. It can be fed via any paper tray.
Thick Paper 3	Thick Paper 3 is paper weighing between 55.75 to 68 lb bond. It can be fed via any paper tray.
Thick Paper 4	Thick Paper 4 is paper weighing between 68.25 to 79.75 lb bond. It can be fed via the bypass tray.
Special Paper	A thin or other specialty type paper that falls within the paper weight specification and appears on the Recommended Paper Stock List.
OHP	Specify [OHP] to a tray to which transparent films are loaded. It can be fed only via the bypass tray (20 sheets or less). Black and white printing supported only.
Envelopes	Specify [Envelope] for bypass tray.
Postcards	A Postcard is defined as a rectangular piece of the thick paper or thin cardboard. This product series supports 4" x 6" size postcards. Postcards are fed only via the Bypass Tray.
Tab Dividers	A stiff sheet with divider tabs. Tab Divider sheets can only be fed (long edge only) via the Bypass Tray.
Banner Paper	An 11.75" x 47.25" paper that is fed via the Bypass Tray to create banners.

Recommended Paper Stocks			
Class.	Weight	Brand of Paper	Size
Plain Paper – Color			
Plain Paper	20 lb Bond (75 gr)	Domtar Recycled Copy (30% Post Consumer)	8.5" x 11"
Plain Paper	22 lb Bond (80 gr)	Konica Minolta CF Paper	8.5" X 11"
Plain Paper	22 lb Bond (80 gr)	Konica Minolta CF Paper	11" X 17"
Plain Paper	22 lb Bond (80 gr)	Konica Minolta CF Paper	12" X 18"
Plain Paper	24 lb Bond (89 gr)	SMART Carnival Stellar White	8.5" x 11"
Plain Paper	24 lb Bond (89 gr)	SMART Carnival White	8.5" x 11"
Plain Paper	24 lb Bond (90 gr)	SMART Synergy Bond 25% Cotton	8.5" x 11"
Plain Paper	24 lb Bond (90 gr)	Domtar Microprint Laser	8.5" x 11"
Plain Paper	24 lb Bond (90 gr)	Mohawk Color Copy 98 Bright White	8.5" x 11"
Thick 1	28 lb Bond (105 gr)	Konica Minolta CF Paper	8.5" X 11"
Thick 1	28 lb Bond (105 gr)	Konica Minolta CF Paper	11" X 17"
Thick 1	28 lb Bond (105 gr)	Konica Minolta CF Paper	12" X 18"
Thick 1	28 lb Bond (105 gr)	Domtar Microprint Color Copy	8.5" x 11"
Thick 1	32 lb Bond (120 gr)	Hammermill Color Copy	8.5" X 11"
Thick 1	32 lb Bond (120 gr)	Hammermill Color Copy Paper – Photo White	8.5" x 11"
Thick 2	60 lb Cover (163 gr)	Hammermill Color Copy	8.5" X 11"
Thick 3	80 lb Cover (216 gr)	Hammermill Color Copy	8.5" X 11"
Thick 4	100 lb Cover (271 gr)	Hammermill Color Copy	8.5" X 11"
Plain Paper – B/W			
Plain Paper	20 lb Bond (75 gr)	Hammermill Tidal MP	8.5" X 11"
Single-Sided Glossy			
Thick 3	10 pt Cover (219 gr)	SMART Kromekote Laser High Gloss Coated One Side 10 pt Cover	8.5" x 11"
Thick 3	12 pt Cover (247 gr)	SMART Kromekote Laser High Gloss Coated One Side 12 pt Cover	8.5" x 11"
Double-Sided Glossy			
Thick 1	32 lb Bond (120 gr)	Mohawk Color Copy Gloss Pure White	8.5" x 11"
Thick 1	80 lb Text (118 gr)	Sappi Opus Gloss	8.5" x 11"
Thick 1	90 lb Text (133 gr)	SMART Kromekote Laser High Gloss Coated Two Sides*	8.5" x 11"
Thick 3	80 lb Cover (216 gr)	Mohawk Color Copy Gloss Pure White	8.5" x 11"
Thick 3	80 lb Cover (216 gr)	Sappi Opus Gloss Cover	8.5" x 11"

* Paper cannot be used in a high humidity environment.

continued

Recommended Paper Stocks			
Class.	Weight	Brand of Paper	Size
Double-Sided Glossy continued			
Class.	Weight	Brand of Paper	Size
Thick 3	80 lb Cover (216 gr)	Domtar Microprint Coated Laser Gloss Cover	8.5" x 11"
Thick 3	10 pt Cover (234 gr)	SMART Kromekote Laser High Gloss Coated Two Sides 10 pt Cover	8.5" x 11"
Thick 3	90 lb Cover (237 gr)	SMART Kromekote® Plus C2S Cover	8.5" x 11"
Thick 4	100 lb Cover (270 gr)	Mohawk Color Copy Gloss Pure White 100C	8.5" x 11"
Cover Stock			
Thick 2	60 lb Cover (163 gr)	Domtar Microprint Color Copy Cover	8.5" x 11"
Thick 2	65 lb Cover (176 gr)	Domtar Microprint Color Copy Cover	8.5" x 11"
Thick 3	80 lb Cover (216 gr)	Domtar Microprint Coated Laser Matte Cover	8.5" x 11"
Thick 3	80 lb Cover (216 gr)	Domtar Microprint Color Copy Cover	8.5" x 11"
Thick 3	80 lb Cover (216 gr)	SMART Carnival White Cover	8.5" x 11"
Thick 3	140 lb Index (255 gr)	Wausau Exact Index	8.5" x 11"
Thick 3	80 lb Cover (216 gr)	Mohawk Color Copy 98 Bright White	8.5" x 11"
Thick 4	100 lb Cover (270 gr)	Mohawk Color Copy 98 Bright White	8.5" x 11"
Labels			
Avery Dennison 5889 Postcard			8.5" x 11"
Avery Dennison 6870 (30 labels per sheet)			8.5" x 11"
Avery Dennison 6873 (8 labels per sheet)			8.5" x 11"
Avery Dennison 6876 (2 labels per sheet)			8.5" x 11"
Avery 6878 4-UP labels for Color Laser			8.5" x 11"
Envelopes			
Envelopes	24 lb	Preservation Wove 5789 #6 3/4	3.85" x 6.5" (98 x 165 mm)
Tab Dividers			
Avery Dennison 20406 (long edge only)			8.5" x 11"
Specialty Paper			
Thick 2	—	TECHNI-Print 9721PO* T-shirt Transfer Paper**	8.5" x 11"
Transparency			
OHP Sheets	—	3M-PP2500	8.5" x 11"
Banner Paper			
Banner Mode/ Thick 1	100 lb Text (180 gr)	Konica Minolta Banner Paper	11.75" x 47.25"

* Paper cannot be used in a high humidity environment.

**T-Shirt Transfer Paper: The C4050i/C3350i Series should not be used solely for T-shirt transfer applications. T-Shirt transfer paper should be used on a limited basis, not to exceed a 250-sheet per run maximum. If a misfeed should occur, clear it immediately (due to the odor) and then run 15-25 sheets of regular plain paper (20 lb) through the device to clean the fusing rollers. T-Shirt Transfer paper cannot be used in high humidity environments.

How to Build a System for the bizhub C4050i/C3350i Digital Printer/Copier/Scanner/Fax (from start to finish)

Step 1: Base Unit		Step 4: Additional Options	
<input checked="" type="checkbox"/>	C4050i Digital Color Printer/Copier/Scanner/Fax/Finisher Includes PS, PCL & XPS Controller, 5 GB Memory, 250 GB SSD, Standard Wireless Connectivity and Web Browser, Standard Super G3 Fax, Standard Gigabit Ethernet, Duplex Unit, 50-sheet Dual Scan Document Feeder, Standard USB 2.0 (supports local printing), CMYK Toner (Yield: 9K/13K) and Imaging Units.	<input type="checkbox"/>	AU-102 Biometric Authentication*
<input checked="" type="checkbox"/>	C3350i Digital Color Printer/Copier/Scanner Includes PS, PCL & XPS Controller, 5 GB Memory, 250 GB SSD, Standard Wireless Connectivity and Web Browser, Standard Gigabit Ethernet, Duplex Unit, 50-sheet Dual Scan Document Feeder, Standard USB 2.0 (supports local printing), CMYK Toner (Yield: 9K/13K) and Imaging Units.	<input type="checkbox"/>	AU-205H IC Card Reader**
Step 2: Paper Handling Options		<input type="checkbox"/>	MK-P08 Mount Kit for Card Reader
<input type="checkbox"/>	PF-P21 Paper Feed Unit (500 sheets, maximum 2)	<input type="checkbox"/>	EK-P08 USB Connection Kit
<input type="checkbox"/>	PF-P25 Height Adjustment Unit	<input type="checkbox"/>	EK-P09 USB Connection Kit – Bluetooth
<input type="checkbox"/>	DK-P05 Copy Desk	<input type="checkbox"/>	KP-102 10-Key Pad
Step 3: Finishing Options		<input type="checkbox"/>	FK-517 Fax Kit (Option for C3350i only)
<input type="checkbox"/>	FS-P04 Off-Line Stapler	<input type="checkbox"/>	WT-P03 Working Table
<input type="checkbox"/>	CS-1 Convenience Stapler	<input type="checkbox"/>	LK-102 v3 i-Option License Kit (Enhanced PDF Encryption, PDF/A (1a/1b) and Linearized PDF support)
		<input type="checkbox"/>	LK-104 v3 i-Option License Kit (Voice Guidance)
		<input type="checkbox"/>	LK-105 v4 (Searchable PDF)
		<input type="checkbox"/>	LK-106 i-Option License Kit (Barcode Font Printing)
		<input type="checkbox"/>	LK-107 i-Option License Kit (Unicode Font Printing)
		<input type="checkbox"/>	LK-108 i-Option License Kit (OCR Font Printing)
		<input type="checkbox"/>	LK-110 v2 i-Option License Kit (OOXML file conversion, Enhanced Image Data, Combines LK-102 & LK-105 functionality)
		<input type="checkbox"/>	LK-111 i-Option License Kit (ThinPrint® Client Support)
		<input type="checkbox"/>	LK-116 i-Option License Kit (Bitdefender Virus Scan)



* WT-P03 required.
 ** WT-P03 or MK-P08 required for mounting.

Accessory Options for bizhub C4050i/C3350i Digital Color Printer/Copier/Scanner/Fax			
ITEM	ITEM NO.	DESCRIPTION	NOTES
BASE UNIT			
bizhub C4050i	AAJN011	Digital Color Printer/Copier/Scanner/Fax/Finisher	Includes PS, PCL & XPS Controller, 5 GB Standard Memory, 250 GB SSD, Standard Wireless Connectivity and Web Browser, Standard Super G3 Fax, Standard Gigabit Ethernet, Duplex Unit, 50-sheet Automatic Duplex Document Feeder, Standard USB 2.0 (supports local printing), CMYK Toner (Yield: 9K/13K) and Imaging Units.
bizhub C3350i	A92F011X011	Digital Color Printer/Copier/Scanner	Includes PS, PCL & XPS Controller, 5 GB Standard Memory, 250 GB SSD, Standard Wireless Connectivity and Web Browser, Standard Gigabit Ethernet, Duplex Unit, 50-sheet Automatic Duplex Document Feeder, Standard USB 2.0 (supports local printing), CMYK Toner (Yield: 9K/13K) and Imaging Units.
PAPER HANDLING OPTIONS			
DK-P05	135900	Copy Desk	Adds storage and mobility. Brings MFP up to working height.
PF-P21	AAJUW11	Paper Feed Unit	Lower feeder unit adds 500 sheets of paper capacity (8.5" x 11" or 8.5" x 14"). Add up to 2. Total paper capacity: 1,650 sheets.
PF-P25	AAJUW12	Height Adjustment Unit	Increases height of machine.
FINISHING OPTIONS			
CS-1	7640013463	Convenience Stapler	Standalone electronic stapler.
FS-P04	ACCGWY1	Stapler	Provides 20-sheet corner stapling off-line finisher.
ADDITIONAL OPTIONS			
AU-102	A0X9WY1	Biometric Authentication Unit	Scans finger vein patterns to enable users to gain access to the device. Requires WT-P03 Working Table.
AU-204H	7640013468	Magnetic Stripe Card Reader	Allows authorized access to the MFP using Magnetic Stripe Cards. Requires WT-P03 Working Table.
AU-205H	R5427000136466	IC Card Reader	Allows access to the MFP via HID Proximity Cards. Working table recommended. Supports IC card types.
AU-211P	—	CAC/PIV Solution with Certificate	Requires WT-P03 Working Table. Contact your local Government Account Manager for information.
EK-P08	ACCTWY1	Local USB Interface Kit	Required to connect optional external keyboard and supports Voice Guidance functions available with optional LK-104 v3.
EK-P09	ACCVWY1	Local USB Interface Kit	Required to connect optional external keyboard, provides bluetooth printing support for mobile phone link and supports Voice Guidance functions available with optional LK-104 v3.
External Keyboard	7640006869	External Keyboard	Computer type keyboard for alphanumeric data entry (alternative to the standard QWERTY keyboard available on the MFP's LCD). Requires either EK-P08 or EK-609 and KH-P02.
FK-517	AA1K011	Fax Kit	Adds Super G3 fax functionality for the bizhub C3351 (standard for the bizhub C3851FS).
KH-P02	ACCFWY1	Keyboard Holder	Holds the optional QWERTY keyboard in place on the MFP.
KP-102	AACJWY1	10-Key Pad	Optional 10 Key Pad. Supports Voice Guidance function available with optional LK-104 v3 i-Option License Kit. Affixes to the right-hand side of the control panel.
LK-102 v3	A0PD016	i-Option License Kit	Enables 128-bit AES PDF encryption; PDF File and password are encrypted; provides PDF/A (1a/1b) and Linearized PDF file format support. Please note that the LK-110 V2 supports the same functions as the LK-102 v3, therefore, both license kits cannot be installed on the same device.
LK-104 v3	A0PD017	i-Option License Kit	Provides Voice Guidance functionality.
LK-105 v4	A0PD118	i-Option License Kit	Provides Searchable PDF functionality. Please note that the LK-110 v2 supports the same functions as the LK-105 v4, therefore, both license kits cannot be installed on the same device.
LK-106	A0PD019	i-Option License Kit	Provides Bar Code Font printing support.
LK-107	A0PD01F	i-Option License Kit	Provides Unicode Font printing support.

*Not available at time of launch.

Accessory Options for bizhub C4050i/C3350i Digital Color Printer/Copier/Scanner/Fax

ITEM	ITEM NO.	DESCRIPTION	NOTES
ADDITIONAL OPTIONS <small>continued</small>			
LK-108	A0PD11G	i-Option License Kit	<i>Provides OCR Font printing support.</i>
LK-110 v2	A0PD11U	i-Option License Kit	<i>Provides DOCX, XLSX format file conversion, Fax to searchable PDF, convert print data in box to compact PDF, combines LK-102 (encrypted PDF) & LK-105 (searchable PDF/OCR) functionality. Please note that if you install the LK-110 V2 on a device, you cannot install the LK-102 v3 and/or LK-105 v4 on the same device.</i>
LK-111	A0PD01K	i-Option License Kit	<i>Provides ThinPrint client support.</i>
LK-116	A0PDAA1	i-Option License Kit	<i>Bitdefender® antivirus provides real time scanning of all incoming and outgoing data.</i>
MK-P08	ACCKWY1	Mount Kit	<i>Internal mount kit for AU-205H HID Card Authentication Units. Required if card readers are not mounted using the WT-P03 Working Table.</i>
WT-P03	ACCRWY1	Working Table	<i>Recommended for use with FS-P04, CS-1 or Authentication Units.</i>

CONSUMABLE YIELDS*

CONSUMABLE	ITEM NO.	YIELD
TN-P79K Toner – Black	AAJW130	13,000
TN-P79C Toner – Cyan	AAJW430	9,000
TN-P79M Toner – Magenta	AAJW330	9,000
TN-P79Y Toner – Yellow	AAJW230	9,000
IU-P35K Drum Imaging Unit – Black	AAJV01D	200,000
IU-P35C Drum Imaging Unit – Cyan	AAJV0HD	100,000
IU-P35M Drum Imaging Unit – Magenta	AAJV0CD	100,000
IU-P35Y Drum Imaging Unit – Yellow	AAJV06D	100,000
Waste Toner Box	ACDN0Y1	(C4050i) 27,400 (C3350i) 26,800
Fusing Unit	AAJRR70300	400,000

* Based on 5% total coverage.

Notes

PARTNERSHIP.

Konica Minolta can help give shape to your ideas and partner with you to achieve your corporate objectives. Contact us to realize opportunities in:

INFORMATION MANAGEMENT

Enterprise Content Management (ECM)
Document Management
Automated Workflow Solutions
Business Process Automation
Security and Compliance
Mobility
eDiscovery Services

IT SERVICES

Application Services
Cloud Services
IT Security
Managed IT Services
IT Consulting & Projects
Apple Managed Services
Managed Voice Services
Technology Implementation and Deployment

TECHNOLOGY

Office Multifunction Business Solutions
Commercial and Production Printers
Industrial Printers
Wide Format Printers
3D Printers
Scanners
Security Surveillance Systems
Laptops, Desktops and Computer Hardware
Servers and Networking Equipment
Managed Print Services (MPS)
Managed Enterprise Services

For complete information on Konica Minolta products and solutions, please visit: CountOnKonicaMinolta.com

©2019 KONICA MINOLTA BUSINESS SOLUTIONS U.S.A., INC. All rights reserved. Reproduction in whole or in part without written permission is prohibited. KONICA MINOLTA, the KONICA MINOLTA logo, bizhub and Giving Shape to Ideas are registered trademarks or trademarks of KONICA MINOLTA, INC. All other product and brand names are trademarks or registered trademarks of their respective companies or organizations. All features and functions described here may not be available on some products. Design & specifications are subject to change without notice.



KONICA MINOLTA

KONICA MINOLTA BUSINESS SOLUTIONS U.S.A., INC.
100 Williams Drive, Ramsey, New Jersey 07446

CountOnKonicaMinolta.com



Item #: C4050SeriesSIG
06/06/2019